

# Serie 250

## CONNESSIONI AUTOMOTIVE

### Connettori

Connettori: PP  
Terminali: ottone

TERMINALE  
FEMMINA **F**

TERMINALE  
MASCHIO **M**

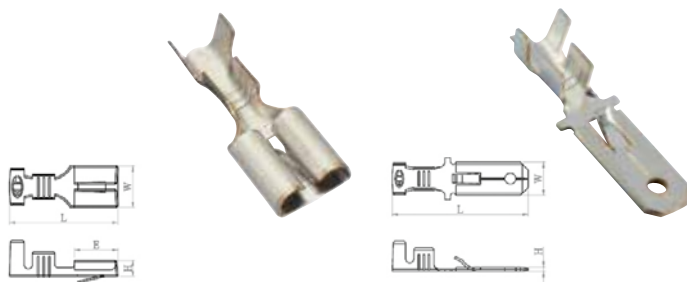

RIF	CODICE	MATERIALE	TRATTAM.	SEZ. FILO	H	W	L	E	SPESS.	CONF.	NOTE
F	E604501	BS	0 / 2	2.0 - 3.0	2.9	7.5	19.4	7.8	0.3	4.000	
	E1761BS	BS	0 / 2	0.75 - 1.25	2.9	7.5	19.3	7.8	0.3	5.000	
	E604503	BS	0 / 2	0.3 - 0.50	2.9	7.5	19.3	7.8	0.3	6.000	
M	E605501	BS	0 / 2	2.0 - 3.0	0.8	6.0	24.5	14.0	0.4	4.000	
	E1661BS	BS	0 / 2	0.75 - 1.25	0.8	6.0	24.5	14.0	0.4	5.000	
	E605503	BS	0 / 2	0.3 - 0.50	0.8	6.0	24.5	14.0	0.4	5.000	

CONNETTORE  
PORTA FEMMINA

EPPKLI7711  
1VIA



**A**

CONNETTORE  
PORTA MASCHIO

EPPKLI6611  
1VIA

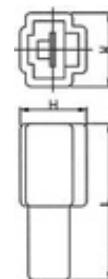

**B**

CONNETTORE  
PORTA FEMMINA

EPPKLI7612T  
2VIE

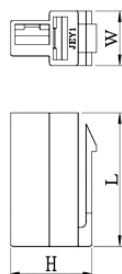

**C**

CONNETTORE  
PORTA MASCHIO

EPPKLI6612T  
2VIE

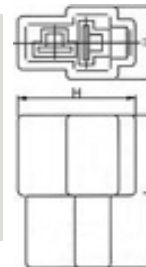

**D**

CONNETTORE  
PORTA FEMMINA

EPPKLI7613  
3VIE

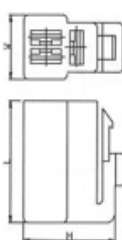

**E**

CONNETTORE  
PORTA MASCHIO

EPPKLI6613  
3VIE

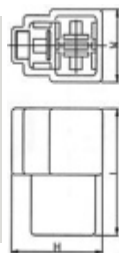

**F**

CONNETTORE  
PORTA FEMMINA

EPPKLI7614  
4VIE



**G**

CONNETTORE  
PORTA MASCHIO

EPPKLI6614  
4VIE

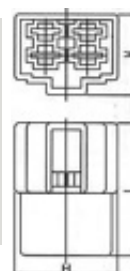

**H**

# Serie 250

## CONNESSIONI AUTOMOTIVE

### Connettori

CONNETTORE  
PORTA FEMMINA

**EPPKLI7616**  
6VIE

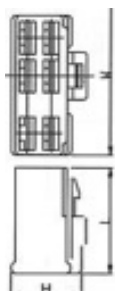

I

CONNETTORE  
PORTA MASCHIO

**EPPKLI6616**  
6VIE

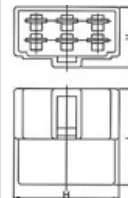

L

CONNETTORE  
PORTA FEMMINA

**EPPKLI7618**  
8VIE

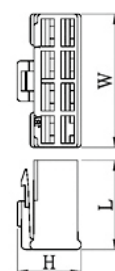

M

CONNETTORE  
PORTA MASCHIO

**EPPKLI6618**  
8VIE

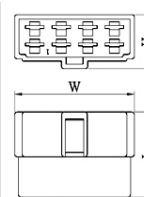

N

RIF	CODICE	MATERIALE	COLORE	TERMINALE	L	H	W	CONF.
A	EPPKLI7711	PP	Naturale	E604901	23.4	6.4	10.0	200
B	EPPKLI6611	PP	Naturale	E605501 E1661BS E605503	28.5	12.6	13.3	200
C	EPPKLI7612T	PP	Naturale	E604501 E1761BS-0 E604503	24.8	18.7	10.0	200
D	EPPKLI6612T	PP	Naturale	E605501 E1661BS E605503	28.5	18.9	13.5	200
E	EPPKLI7613	PP	Naturale	E604501 E1761BS E604503	28.3	31.9	21.7	200
F	EPPKLI6613	PP	Naturale	E605501 E1661BS E605503	28.3	31.9	21.7	200
G	EPPKLI7614	PP	Naturale	E604501 E1761BS E604503	24.8	17.8	19.1	200
H	EPPKLI6614	PP	Naturale	E605501 E1661BS E605503	28.5	22.6	18.0	200
I	EPPKLI7616	PP	Naturale	E604501 E1761BS E604503	24.8	21.2	13.0	100
L	EPPKLI6616	PP	Naturale	E605501 E1661BS E605503	28.5	31.5	18.4	100
M	EPPKLI7618	PP	Naturale	E604501 E1761BS E604503	24.8	21.2	13.0	100
N	EPPKLI6618	PP	Naturale	E605501 E1661BS E605503	28.5	31.5	18.4	100

# Serie 250

## CONNESSIONI AUTOMOTIVE

### Terminali + Connettori

Connettori: NL66  
Terminali: ottone

TERMINALE FEMMINA **F**

TERMINALE MASCHIO **M**

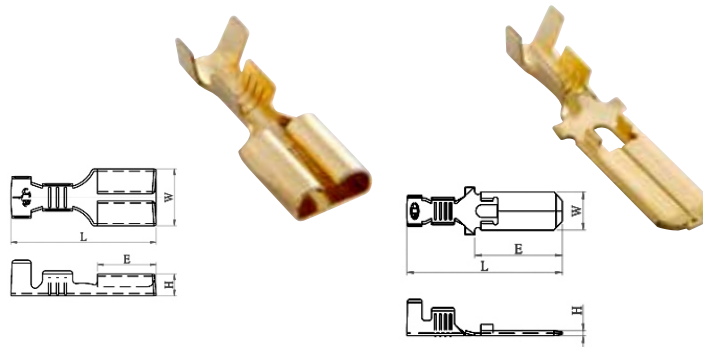

RIF	CODICE	MATERIALE	TRATTAM.	SEZ. FILO	H	W	L	E	SPESS.	CONF.	NOTE
F	E17618BS	BS	0 / 2	0.85 - 1.25	2.9	7.5	19.3	7.8	0.3	5.000	
M	E16601BS	BS	0 / 2	0.85 - 1.25	0.8	6.0	24.5	13.8	0.4	5.000	

CONNETTORE PORTA FEMMINA

ENPK1762I  
1VIA

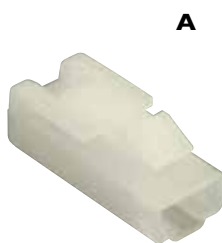
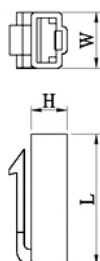

**A**

CONNETTORE PORTA MASCHIO

ENPK1660I  
1VIA

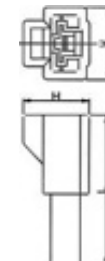

**B**

CONNETTORE PORTA FEMMINA

ENPK17622T  
2VIE

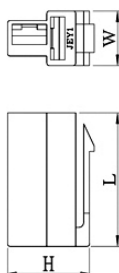

**C**

CONNETTORE PORTA MASCHIO

ENPK16602T  
2VIE

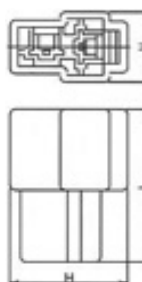

**D**

RIF	CODICE	MATERIALE	COLORE	TERMINALE	L	H	W	CONF.
A	ENPK1762I	NL 66	Naturale	E60453I E17618BS E604533	24.9	6.4	10.0	200
B	ENPK1660I	NL 66	Naturale	E60551I E16601BS E605513	29.0	12.6	13.5	200
C	ENPK17622T	NL 66	Naturale	E60453I E17618BS E604533	25.0	15.3	10.0	200
D	ENPK16602T	NL 66	Naturale	E60551I E16601BS E605513	28.3	21.6	13.2	200

# Serie 250

## CONNESSIONI AUTOMOTIVE

### Connettori

CONNETTORE  
PORTA FEMMINA

ENPK I 7623  
3VIE



CONNETTORE  
PORTA MASCHIO

ENPK I 6603  
3VIE

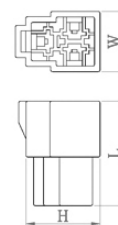

CONNETTORE  
PORTA FEMMINA

ENPK I 7624  
4VIE

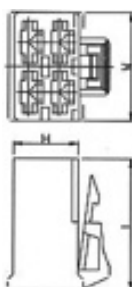

CONNETTORE  
PORTA MASCHIO

ENPK I 6604  
4VIE

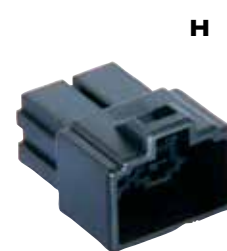
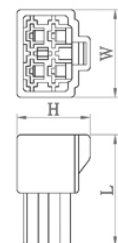

CONNETTORE  
PORTA FEMMINA

ENPK I 7626  
6VIE

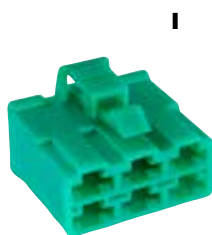
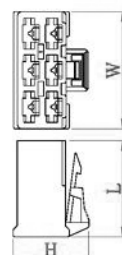

CONNETTORE  
PORTA MASCHIO

ENPK I 6606  
6VIE

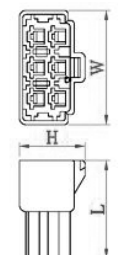

CONNETTORE  
PORTA FEMMINA

ENPK I 7628  
8VIE

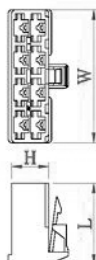

CONNETTORE  
PORTA MASCHIO

ENPK I 6608  
8VIE

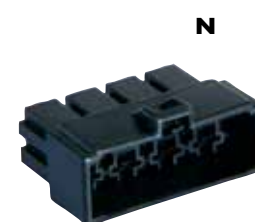
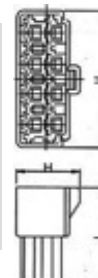

RIF	CODICE	MATERIALE	COLORE	TERMINALE	L	H	W	CONF.	NOTE
E	ENPK I 7623	NL 66	Naturale	EI 76 I 8BS	25.0	16.3	13.0	200	
F	ENPK I 6603	NL 66	Naturale	EI 660 IBS	28.5	23.0	16.6	200	
G	ENPK I 7624	NL 66	Naturale	EI 76 I 8BS	25.0	12.0	19.0	200	
H	ENPK I 6604	NL 66	Naturale	EI 660 IBS	28.5	18.5	22.5	200	
I	ENPK I 7626	NL 66	Naturale	EI 76 I 8BS	25.0	12.0	28.0	200	
L	ENPK I 6606	NL 66	Naturale	EI 660 IBS	28.5	18.5	31.7	200	
M	ENPK I 7628	NL 66	Naturale	EI 76 I 8BS	25.0	12.0	36.8	200	
N	ENPK I 6608	NL 66	Naturale	EI 660 IBS	28.5	18.8	40.7	200	

# Serie 250

## CONNESSIONI AUTOMOTIVE

### Terminali + Connettori

Connettori: NL66 e PBT  
Terminali: ottone

TERMINALE  
FEMMINA **F**

TERMINALE  
FEMMINA **FI**

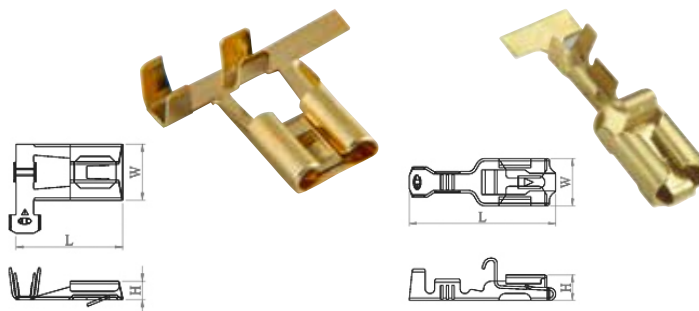

RIF	CODICE	MATERIALE	TRATTAM.	SEZ. FILO	H	W	L	E	SPESS.	CONF.	NOTE
F	E610001	BS	0 / 2	1.25 - 2.00	4.05	7.5	23.0	9.3	0.4	2.500	
FI	E605001	BS	0 / 2	0.85 - 1.25	4.05	7.5	23.0	9.3	0.4	2.000	
	E605003	BS	0 / 2	0.3 - 0.5	4.05	7.5	23.0	9.3	0.4	2.000	

CONNETTORE  
PORTA FEMMINA

**ERB-1BJ**  
IVIA

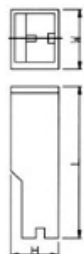

**A**

CONNETTORE  
PORTA FEMMINA

**ESL-3P**  
3VIE

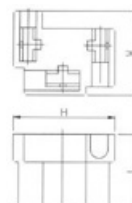

**B**

RIF	CODICE	MATERIALE	COLORE	TERMINALE	L	H	W	CONF.	NOTE
A	ERB-1BJ	NL 66	Naturale	E605001 E605003	24.2	7.3	9.6	100	
B	ESL-3P	ABS PBT+GF	Nero	E610001BS	20.2	27.31	24	100	